

# DRINK RAIL INSTALLATION INSTRUCTIONS

for Aluminum Railing Systems

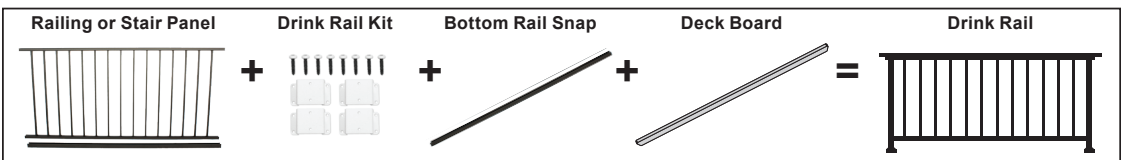
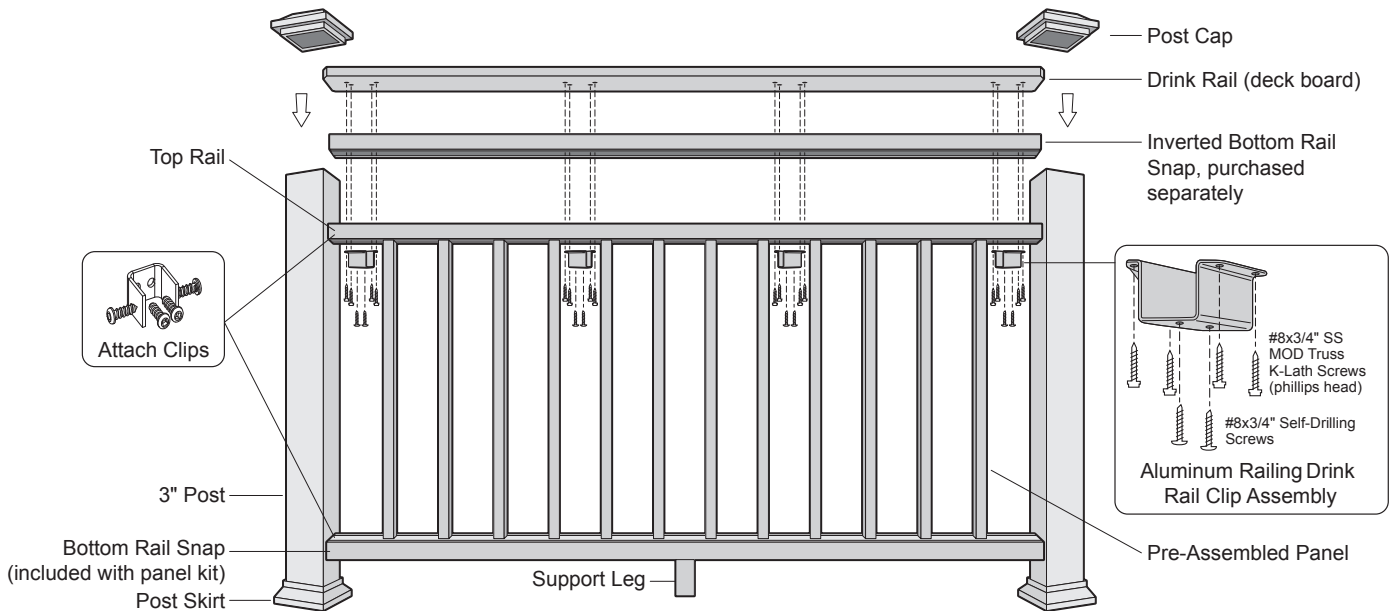
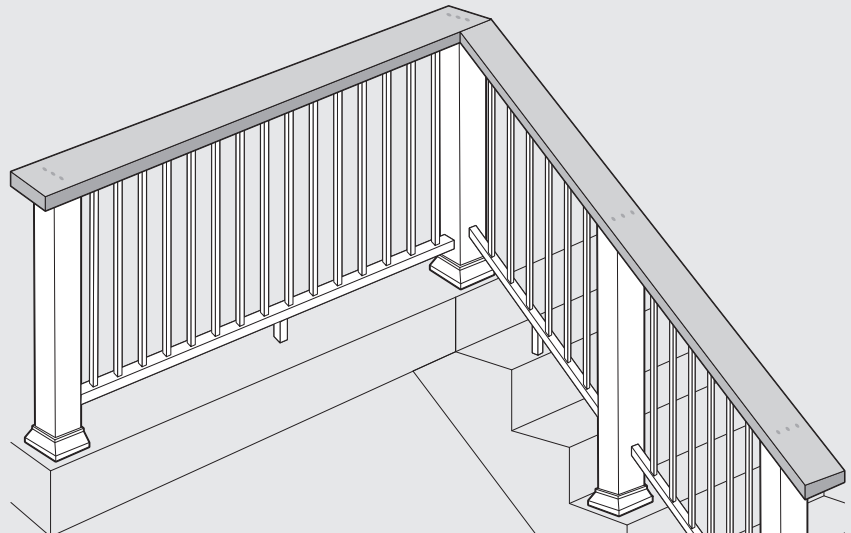
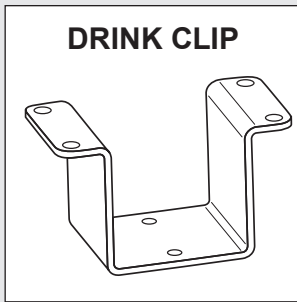

- TOOLS REQUIRED:**
- Miter Saw
  - Tape Measure
  - Cordless Drill
  - #2 Square Drive Bit
  - #2 Phillips Head Drive Bit

**IMPORTANT NOTES:**

- Actual picket panel sizes: 6' Panels = 69.43"; 8' Panels = 91.31".
- 3" posts are required to reach 6' & 8' lengths.
- Stair railing panels are shipped at a 37° angle. Panels are adjustable and will accommodate 30-40° stair angles. **CAUTION:** Over adjusting stair panels will cause loose and rattling pickets.
- 45° deck angles require 22.5° clips applied to each side of the post. The 22.5° clip kit is sold **SEPARATELY**.
- Using 2 Posts at top of stairs is recommended if compound angle cut is required.

- Consult your local building codes for guard and handrail requirements.
- Posts must be installed plumb and level with each other. This is specifically critical for Over-the-Post applications.
- Read instructions completely to get an understanding of how the product goes together and how each piece affects the other.
- It is not recommended to use narrow width (3.5") deck boards in Over-the-Post applications.
- Do not use wide width (7.5") deck boards in Between-the-Post applications.

- The Drink Rail system works with all full profile, square-shoulder deck boards, but **NOT** with scalloped boards.

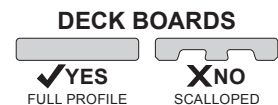

**NOTE: IF INSTALLING POST LIGHTING, WIRING MUST BE INSTALLED PRIOR TO SECURING POSTS TO DECK/STAIR SURFACE AND INSTALLING TOP RAILS.**

It is the responsibility of the installer to meet all local code requirements and obtain all required building permits. The installer should determine and implement appropriate installation techniques for each installation situation. The manufacturer or its reseller shall not be held responsible for improper or unsafe installations.

# These instructions cover installation of the Drink Rail (Deck board Top Rail) on Aluminum Railing Level and Stair Panels.

These instructions **DO NOT** cover the entire rail assembly process. See the manufacturer's Picket Railing Install Instructions to build rail assembly prior to installing Drink Rail.

## IMPORTANT NOTES:

Be sure to cut posts such that finished rail height is at least 36" high for a 36" rail application and 42" high for a 42" application. For a 36" application, posts typically should not be cut less than 35.25". For a 42" application posts typically should not be cut less than 41.25".

**For all rail installations, posts must be plumb and aligned with one another.**

**For Over-the-Post applications, it is also critical that Posts be of a consistent height** (e.g. the tops of all posts are level and on plane with each other and the top of each rail section).

**TIP:** To ensure that the tops of all posts are level, you may use a level panel or a string line to establish a common level across all posts and cut at that level. Alternatively, you may use a laser level to "shoot" a level mark on each post and then cut at that mark.

For a proper finished look on Over-The-Post Drink Rail applications, make sure Inverted Bottom Rail Snap is even with the top of the posts. Prior to installing rail assembly to Post, ensure that rail assembly is positioned (height wise) to eliminate any gaps between Deck board and Inverted Bottom Rail Snap (positioned on top). (Dia. A).

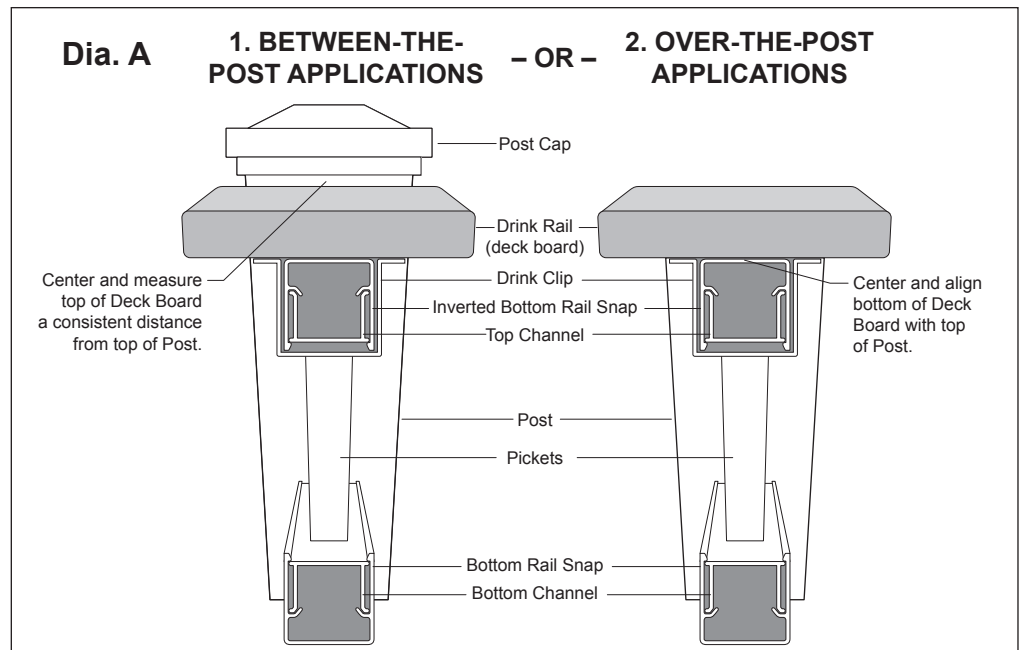

## FOR BEST RESULTS WITH OVER-THE-POST APPLICATIONS :

As is the case when using wood, Over-the-Post applications using deck boards in which boards are mitered in the corners or that use butt joints mid-span are susceptible to those joints opening up or separating over time with changes in temperature. While it may be impossible to completely eliminate joints from separating, there are steps you can take to minimize the separation of the joints. We recommend the following:

- A.** It is critical that all **Post heights are aligned**. In some cases, due to deck surface undulation, the length of posts will vary in order to achieve a level sight line with your top drink rail.
- B.** **Avoid using butt joints whenever possible.** Utilization of butt joints may result in gapping of boards. Good practice is to use a single 16' board rather than using two 8' deck boards
- C.** **Follow all fastener recommendations clearly.**
- D.** Before installing deck boards as drink rails, take all possible measures to **keep the temperature of the boards as low as possible**. The cooler the board at installation, the less apt joints will be to separate or gap. For best results and to minimize gapping, do not store or install deck boards in direct sunlight.
- E.** **Install all joints tight.** Unlike wood boards used in decking applications in which some spacing between boards may be recommended, there should be **NO** gap between the ends of composite deck boards when installed as a drink rail.
- F.** **Not recommended** to use narrow width (3.5") deck boards in Over-the-Post applications.

# INSTALLING DRINK RAIL ON LEVEL PANELS

## 1. CUT BOTTOM RAIL SNAP AND DECK BOARD

Measure, mark and cut the Inverted Bottom Rail Snap (purchased separately) and deck board to length (Dia. #1A). For Over-the-Post applications, cut deck boards so that any seams fall at the center of a post (boards up to 16'). Miter the planks at corner posts.

For Between-the-Post applications if the deck board is wider than posts, if desired, trim deck board corners for a clean finish (Dia. #1B). If using 3 1/2" wide boards, there is no need to trim corners for aluminum post applications. Snap the Inverted Bottom Rail Snap onto the Top Channel until properly seated. TIP: If top snap will not seat, try installing support legs. Then apply pressure to snap starting from one end.

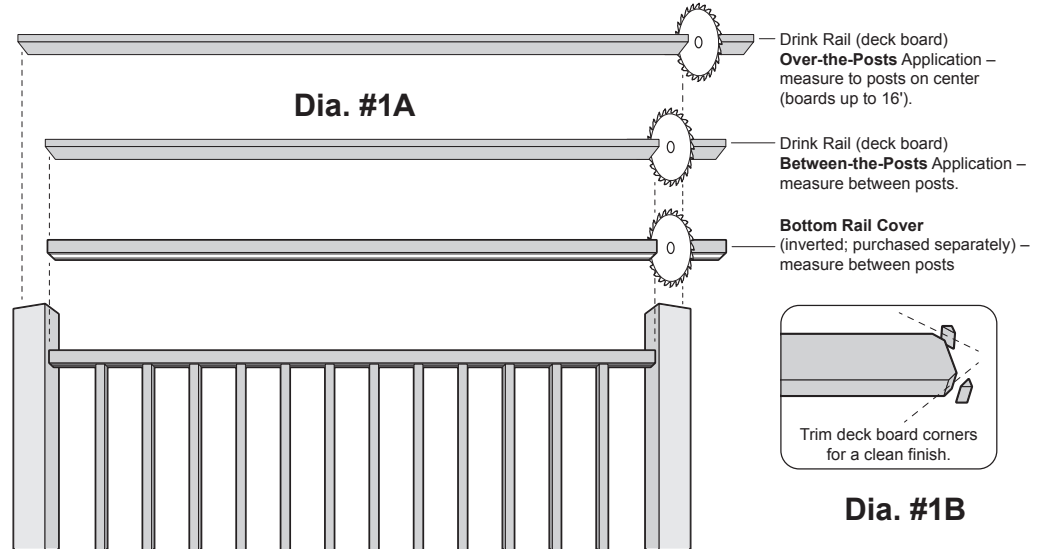

## 2. ATTACH DRINK RAIL CLIPS TO PANEL

Attach drink rail clips every 18" max by running 2 #8 3/4" Self-tapping screws (from drink rail hardware) up through the clip into the rail. (Dia. #2).

- 6' panels require 4 clips, attached within the first picket on each end and then spread equally over the length of the panel.
- 8' panels require 6 clips, attached within the first picket on each end and then spread equally over the length of the panel.
- **For Over-the-Post applications, proceed to Step 3.**
- **For Between-the-Post applications, skip to Step 4.**

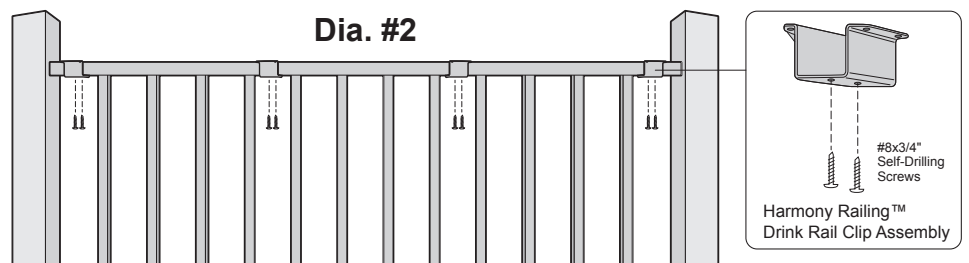

### 3. FASTEN DECK BOARD TO POSTS (OVER-THE-POST APPLICATIONS ONLY)

#### IMPORTANT NOTES:

#### PRIOR TO INSTALLING DECK BOARDS:

It is very important to have the **Inverted Bottom Rail Snap even with the top of the posts** to keep from seeing gaps under the Drink Rail.

The tops of all **posts must be within 1/4" of the tops of rail snaps** for proper fastening of deck boards.

For **Over-the-Post Applications**, cut wood inserts from 4x4 wood boards to fit inside posts. Partially drive a wood screw into wood insert to hold it in place during post bracket attachment (remove afterwards). While holding wood insert, install screws (from Panel Attach Kit) through bracket and post into wood insert. (Dia. #3A)

For **Over-the-Post Applications**, fasten deck board to wood post inserts with (3) 2 1/2" length screws that are appropriate for wood, composite or PVC decking on either side of the butt joint. Note that predrilling may be required for composite boards. **Fasten no closer than 3/4" from the outside edge and ends of each plank** (Dia. #3B, 3C). Make sure that boards are tight together at butt joints and no gap is left. **For proper screw placement, measure 1 1/4" from center of board to ensure full contact with wood post insert** (Dia. #3C).

**TIP:** Pre-drilling significantly reduces spinouts in end grain. Pre-drill through deck plank only, not into structural post. It is also suggested to drill only half way through the plank. Pre-drilling requirements vary distinctly by collection. See the Deck Install Guide for details.

#### IMPORTANT NOTES:

- Pre-drilling with a 3/16" drill bit is always required when installing in full profile/solid profile decking.
- The fastener must be driven perpendicular to the deck surface for proper fit and ideal finished look.

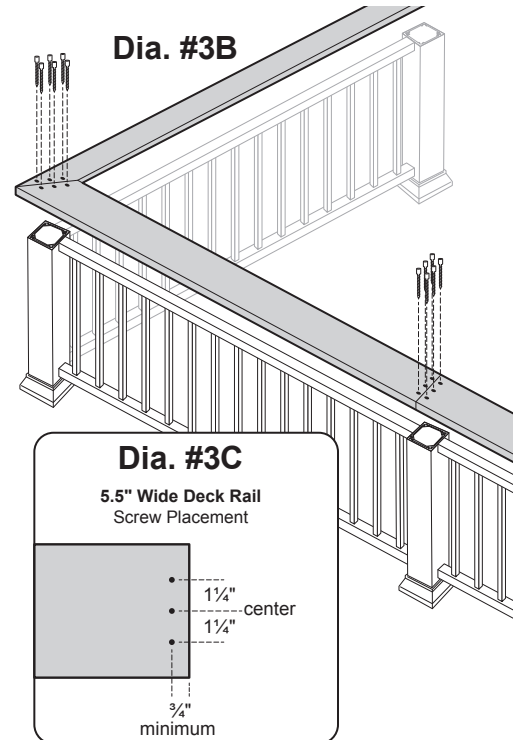
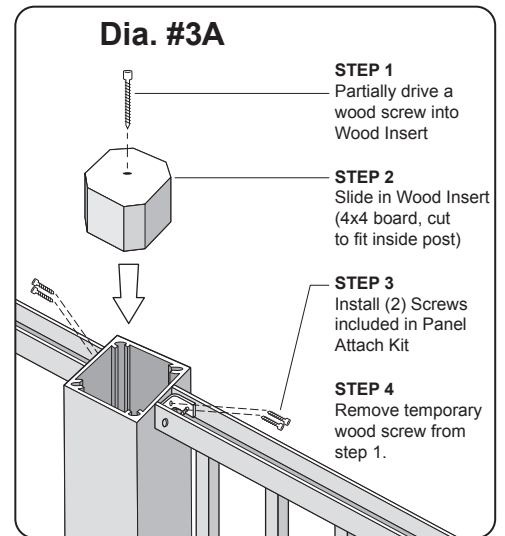

## 4. ATTACH DRINK RAIL CLIPS TO DECK BOARD

Place the Deck Board on top and centered over the Inverted Bottom Rail Snap. For both **Between-the-Post (Dia #4A)** and **Over-the-Post and Applications (Dia #4B)**, secure Drink Rail Clips to Deck Board using #8x3/4" SS MOD Truss K-Lath Screws (phillips head) included with the Drink Rail Clip Kits.

### IMPORTANT NOTE:

Set the Drink Rail in place and use the Drink Clip holes to mark locations. Then drill 1/8" diameter hole 11/16" deep into the bottom of the deck board. Care must be taken not to drill through the top of the deck board.

#### Dia. #4A - Between-the-Post Applications

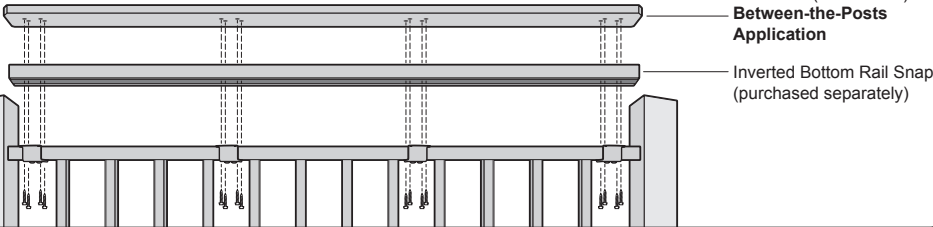

#### Dia. #4C



#### Dia. #4B - Over-the-Post Applications

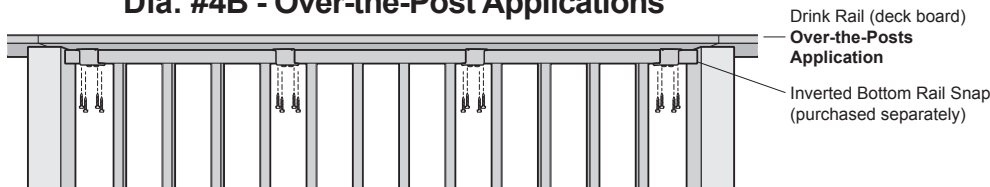

## 5. ATTACH POST CAPS (BETWEEN-THE-POST APPLICATIONS)

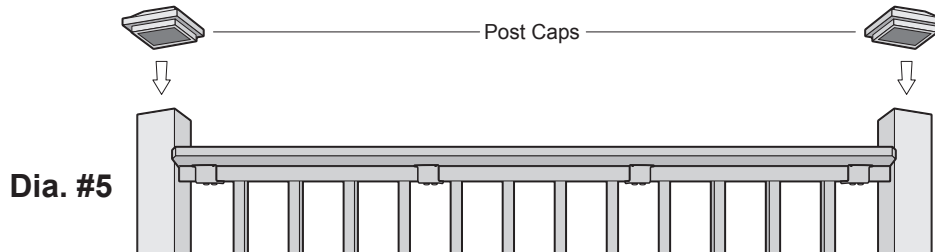

# INSTALLING DRINK RAIL ON STAIR PANELS

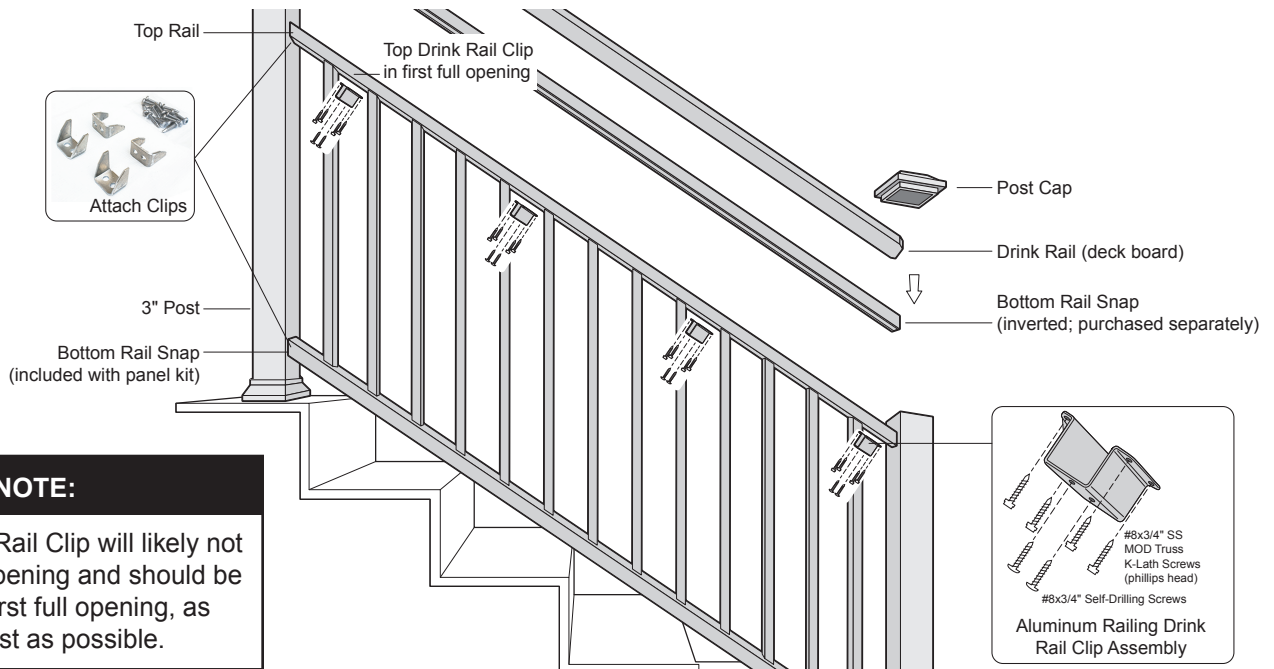

## IMPORTANT NOTE:

The top Drink Rail Clip will likely not fit in the first opening and should be placed in the first full opening, as close to the post as possible.

## 1. CUT INVERTED BOTTOM RAIL SNAP AND DECK BOARD

Measure, mark and cut the Inverted Bottom Rail Snap (purchased separately) and deck board to length (Dia. #1A). For Over-the-Post applications, cut deck boards so that any seams fall at the center of a post (boards up to 16'). Miter the planks at corner posts.

For Between-the-Post applications if the deck board is wider than posts, if desired, trim deck board corners for a clean finish (Dia. #1B). Place the Inverted Bottom Rail Snap on the top channel between the posts.

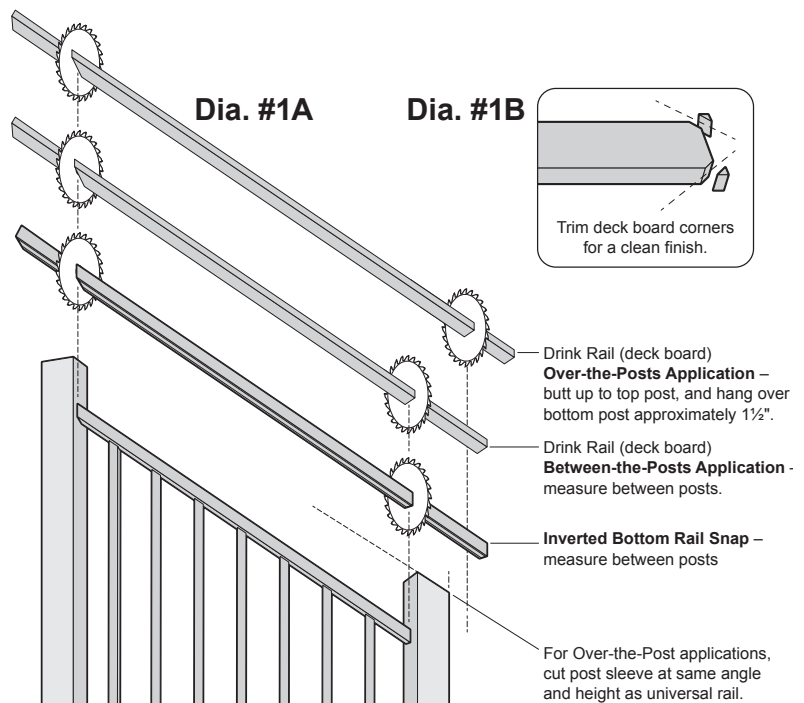

## 2. ATTACH DRINK RAIL CLIPS TO PANEL

Attach drink rail clips every 18" max by running 2 #8 3/4" Self-tapping screws (from drink rail hardware) up through the clip into the rail. (Dia. #2).

- 6' panels require 4 clips, attached within the first picket on each end and then spread equally over the length of the panel.
- 8' panels require 6 clips, attached within the first picket on each end and then spread equally over the length of the panel.
- For Over-the-Post applications, proceed to Step 3.
- For Between-the-Post applications, skip to Step 4.

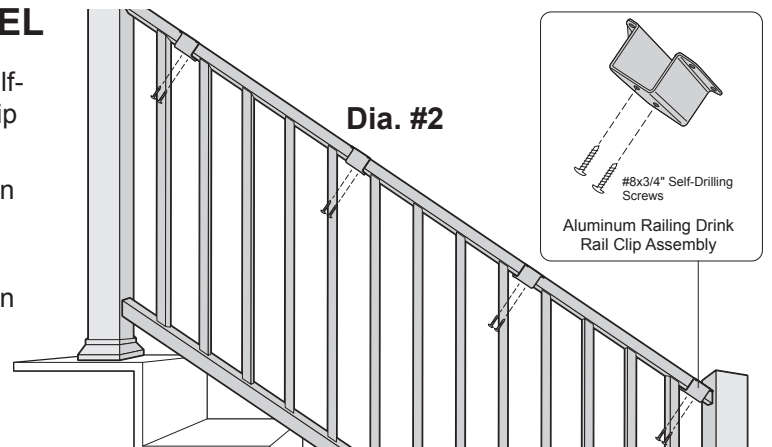



### 3. FASTEN DECK BOARD TO POSTS

#### IMPORTANT NOTES:

#### PRIOR TO INSTALLING DECK BOARDS:

It is very important to have the **Bottom Rail Snap (inverted, positioned on top) even with the top of the posts** to keep from seeing gaps under the Drink Rail.

The tops of all **posts must be within 1/4" of the tops of post snaps** for proper fastening of deck boards.

For **LEVEL Over-the-Post Applications**, cut wood inserts from 4x4" wood boards to fit inside posts. Run one 2-3" screw into the wood insert to hold it in place during post bracket attachment (remove afterwards). While holding wood insert, install screws (from Panel Attach Kit) through bracket and post into wood insert. (Dia. #3A)

For **LEVEL Over-the-Post Applications**, fasten deck board to wood post inserts with (3) 2 1/2" stainless steel screws (not included) on either side of a butt joint. For butt joints, install (3) screws on either side of butt joint into wood post insert. **Fasten no closer than 3/4" from the outside edge and ends of each plank** (Dia. #3B, 3C). Make sure that boards are tight together at butt joints and no gap is left. **For proper screw placement, start with a screw at the center, then sink 2 more screws 1 1/4" from center of board to ensure full contact with wood post insert** (Dia. #3C).

For **STAIR Over-the-Post Applications** (Dia. #3D), fastening to top and bottom posts may not be possible.

**TIP:** Pre-drilling significantly reduces spinouts in end grain. Pre-drill through deck plank only, not into structural post. It is also suggested to drill only half way through the plank. Pre-drilling requirements vary distinctly by deck rail. See manufacturer install guides for details.

#### IMPORTANT NOTES:

- Pre-drilling with a 3/16" drill bit is always required when installing in many deck boards.
- The fastener must be driven perpendicular to the deck surface for proper fit and ideal finished look.
- The interaction between the deck board, screw, and plug is essential.

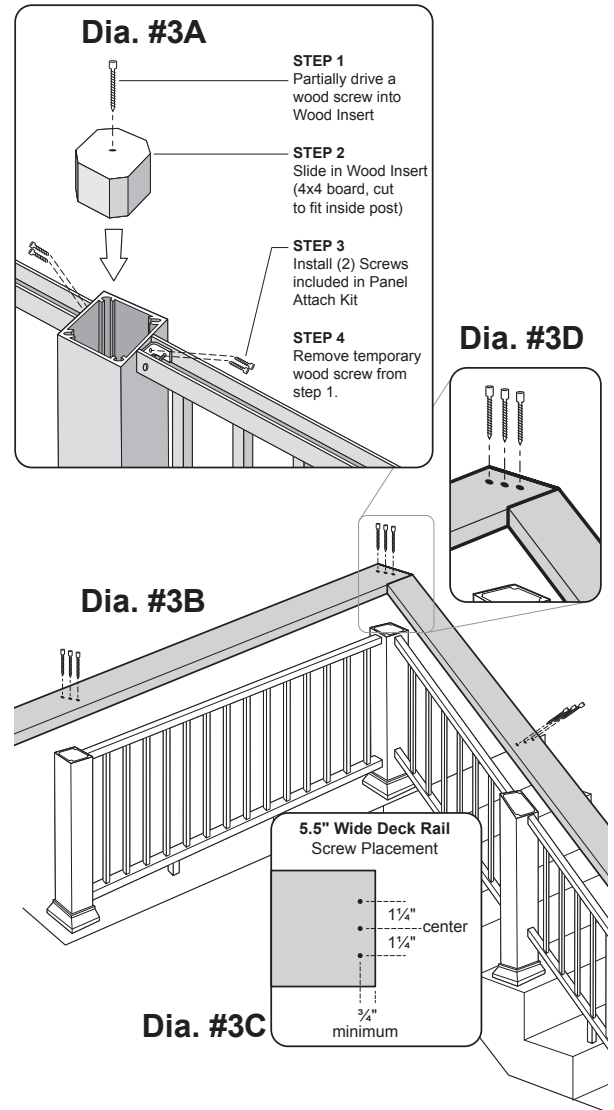

**TIP:** For stairs, it is suggested to install the Drink Rail butted to the top post and over the bottom post. This is based on the ability to anchor the Drink Rail securely at the top and bottom. (Dia. #4B)

## 4. ATTACH DRINK RAIL CLIPS TO DECK BOARD

Place the Deck Board on top and centered over the Inverted Bottom Rail Snap. For both **Between-the-Post (Dia #4A)** and **Over-the-Post and Applications (Dia #4B)**, secure Deck Board and Inverted Bottom Rail Snap to Upper Channel using #8x3/4" SS MOD Truss K-Lath Screws (Phillips head) included with the Drink Rail Clip Kits.

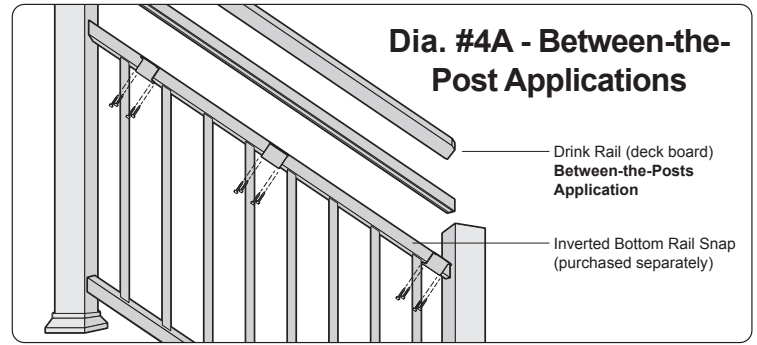

### IMPORTANT NOTE:

Set the Drink Rail in place and use the Drink Clip holes to mark locations. Then drill 1/8" diameter hole 11/16" deep into the bottom of the deck board. Care must be taken not to drill through the top of the deck plank. (Dia. #4C)

### Dia. #4C

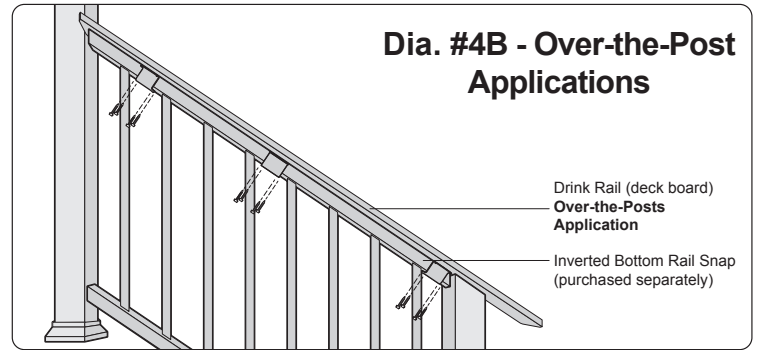
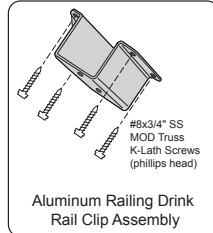

## 5. ATTACH POST CAPS (BETWEEN-THE-POST APPLICATIONS)

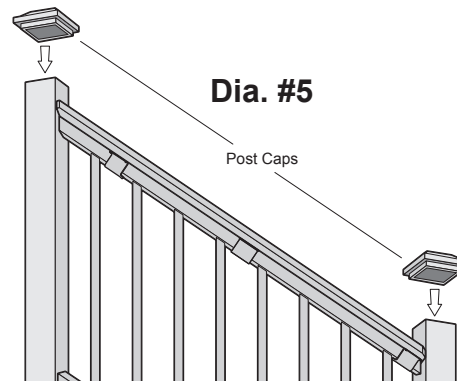

### IMPORTANT NOTE:

The diagrams and instructions in this brochure are for illustration purposes only and are not meant to replace a licensed professional. Any construction or use of the product must be in accordance with all local zoning and/or building codes. The consumer assumes all risks and liability associated with the construction or use of this product. The consumer or contractor should take all necessary steps to ensure the safety of everyone involved in the project, including, but not limited to, wearing the appropriate safety equipment. Except as contained in the written limited warranty, the manufacturer does not provide any other warranty, either express or implied, and shall not be liable for any damages, including consequential damages.

09/21 Version 1.0 part #WIBR094200